



Battery System EFS768-200

Hebei Ecube New Energy Technology Co.,Ltd

 www.ecubeess.com

 dlf@ecube.net.cn

 +86-311-86786213

 Plant 6, No.10 Haihe Road, Gaoxin District, Shijiazhuang China

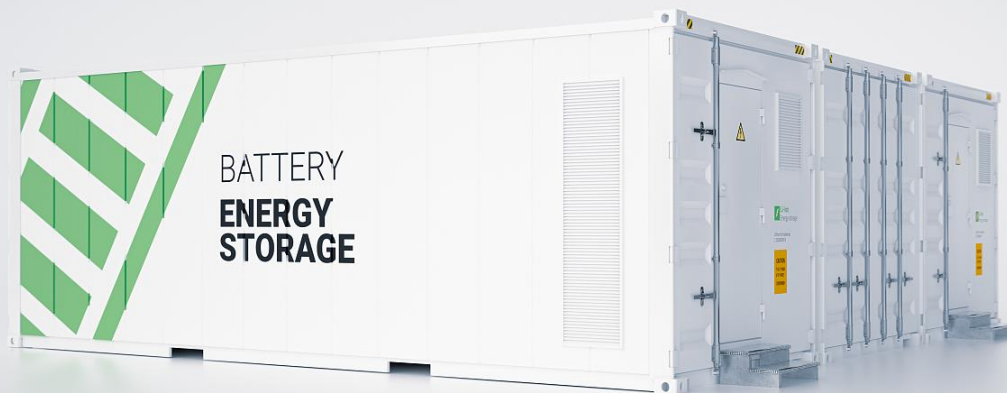

About US

Headquartered in Shijiazhuang, Hebei Ecube New Energy Technology Co., Ltd., with a registered capital of 100 million yuan, is a high-tech enterprise specializing in energy storage and lithium battery system integration. Relying on the technical team of the leading enterprises in the power electronics industry, Ecube has built a core technical team with more than ten years of experience in the development and application of lithium battery and power supply products, and independently developed the industry-leading battery management system with excellent security, stability and balance capabilities.

The products cover four business sectors: Industrial and commercial energy storage system, renewable integration, uninterrupted power lithium battery system and residential energy storage system. In recent two years, the project cases have spread to key overseas markets such as South Korea, Russia, the Netherlands, Germany, the Middle East, etc

Outstanding developers and suppliers of intelligent energy storage system.

Battery system---EFS768-200

Overview

The lithium battery system consists of rack, battery modules, battery management system (BMS), display control system and protection system. 2 level BMS design, hierarchical linkage and multiple monitoring of system status. Relay, fuse, circuit breaker and BMS constitute a comprehensive protection system integrating electrical safety and functional safety.



System topology

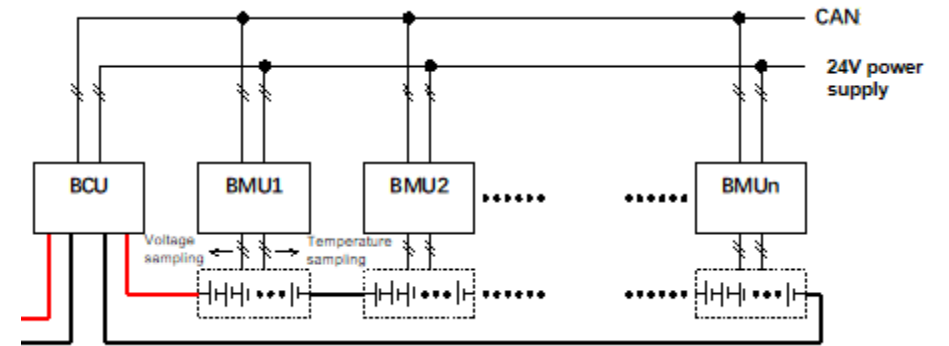

Configuration



Battery System

The system mainly consists of safe, efficient and long-life lithium iron phosphate cells, which are connected in series to form battery modules, and multiple modules are connected in series to form battery clusters.



Battery management system

The core components of the system can effectively protect the battery from overcharge, overdischarge and over-current. At the same time, the balanced management of the cells can ensure the safe, reliable and efficient operation of the whole system.



Power Management System

System operation data monitoring, operation strategy management, historical data record, system status record, etc.

Dimension

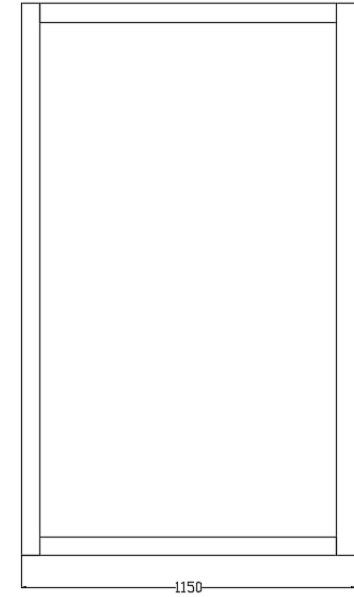
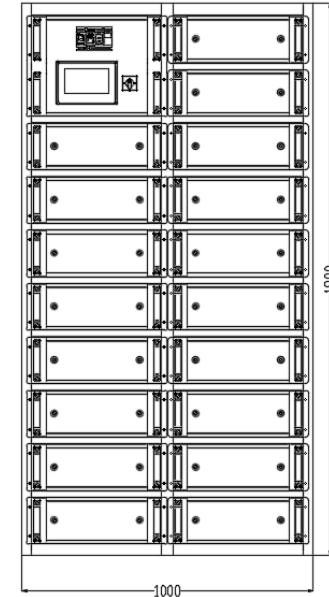

Key product features and benefits

| Safe and reliable |

- Top manufacturer of iron phosphate lithium battery
- Intelligent air cooling design, long service life, stable operation
- Three level BMS design of module, cabinet and system, multiple state monitoring, hierarchical linkage, comprehensive guarantee of battery system safety

| Efficient and Convenient |

- Energy system, high energy density, high integration
- Outstanding high rate performance, maximum 1C charging and 2C discharging
- Modular design, convenient for maintenance, management and expansion

| Active equalization |

- Three level BMS design, energy transferring active equalization, to overcome the impact of single cell capacity on system capacity
- The equalization accuracy is less than 2%, and the equalization capacity can reach 10% of the rated output

| Cost optimization |

- Small size, light weight, less space and installation cost
- Long cycle life, low failure rate, reduce operation and maintenance investment

Application



Industrial and commercial demand management, peak shaving



User side backup power



Peak and frequency regulation, smoothing new energy generation



Building microgrid system

Parameters

Lithium Battery System		
Battery capacity	200Ah	
Rated voltage	768V	
Rated capacity	153.6kWh	
Working voltage range	672V ~ 876V	Single Cell 2.8~3.65
Max. continuous charging current	200A (1C)	
Max. continuous discharging current	400A (2C)	
Working Temperature	Charging: 0°C ~ 45°C Discharging: -20°C ~ 60°C	
Best Working Temperature	15°C ~ 35°C	
Storage temperature	-40°C ~ 60°C	System SOC : Under 20%~40% Within 1 month, -40°C~45°C Within 6 month, -20°C~35°C
Working environment	Altitude: < 2500m Relative humidity: <95% (no condensation)	
System cooling	Controlled air cooling	
Insulation resistance	> 500MΩ@1500VDC	
Isolation and withstand voltage	2500VDC/1min	
Internal power supply mode	24VDC	Built-in DC/DC
Static power consumption	35W	Typical value, module fan not started
Data display	7" TN true color LCD screen	Ratio : 5:3, resolution ratio 800 × 480
IP rating	IP21	
Dimension (W*D*H)	1000mm*1150mm*1900mm	
Weight	1650Kg	
Life cycle	4000 times	1C@25°C charging&discharging @100%DOD, EOL80%
Battery Management System (BMS)		
Cell voltage acquisition range	1-5V	
Cell voltage acquisition accuracy	≤10mV	
Total voltage acquisition accuracy	±1V or ±1%	
Current acquisition range	0~±500ADC	Rated ±400ADC
Current acquisition accuracy	≤±1%	
Temperature acquisition range	-20~125°C	
Temperature acquisition accuracy	≤±1°C	
Charging over current protection	>1C, 10s ;	
Discharging over current protection	>2.2C, 10s ;	
Over temperature protection	Discharging >60°C (20s) Charging >45°C (20s)	The default value of return difference is 15 °C, which can be set
Low temperature protection	Discharging <-20°C (1s) Charging <0°C (1s)	The default value of return difference is 15 °C, which can be set
Communication mode	Can, RS485, dry contact	

Cell

The lithium battery system uses 3.2V 50Ah LFP prismatic cell, which reduces the possibility of cell damage caused by mechanical damage on the cell surface and improves the safety performance of the product. The explosion-proof valve on the top ensure that in any extreme case (such as internal short circuit, battery overcharge and overdischarge), a large amount of gas quickly accumulated in the cell can be discharged through the riot valve,which highly improves the safety.

Parameters		
Battery type	LFP	
Rated capacity ☆	50.0Ah	1C@25°C
Rated voltage ☆	3.20V	
Average working voltage	2.5 ~ 3.65V	
AC-impedance☆	≤1.0mΩ	
Weight	1110±20g	
Max charge current	1.5C	Continuous
	2C	50%SOC, 30s
Max discharge current	2C	Continuous
	5C	50%SOC, 30s
Max operating temperature range	-20°C/ + 60°C	
Charge	0°C ~ 45°C	
Discharge	-20°C ~ 60°C	
Optimal operating temperature range	15°C ~ 35°C	
Storage temperature	-40°C/ + 60°C <1 month -40°C ~ 45°C <6 month -20°C ~ 35°C	
Cycle life	≥4000 times 25°C 1C/1C	

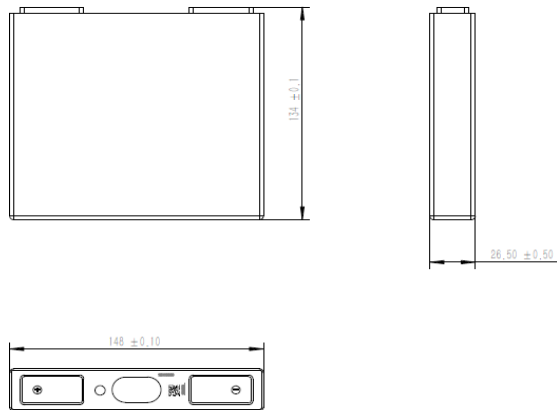

Module

The battery module, 48V200Ah, consists of 60pcs cells (3.2V,50Ah) ,4 in parallel then 15 in series (4p15s). The module has a built-in BMU system, which can collect the voltage and temperature of each cell, and manage the cell balance, so as to ensure the normal operation of the whole module safely and efficiently.

Parameters	
Rated capacity	200Ah
Configuration	4P15S
Rated voltage	48V
Rated energy	9.6kWh
Max continuous charge current	200A (1C)
Max continuous discharge current	400A (2C)
Working voltage range	42 ~ 54.75V
Operating temperature range	-20°C ~ 55°C
Weight	95kg
Dimension (W*D*H)	483mm*980mm*160mm
Cooling	Intelligent fan

